

# +GF+ SIGNET 8750 ProcessPro™ pH/ORP Transmitter



## Features

- Automatic temperature compensation (pH)
- Display in °C or °F
- Hold and Simulate functions
- Integral or remote mounting
- Relay options
- Output scalability
- Dual output option allows temperature and pH signal transmission
- 2 x 16 character dot matrix LCD
- Chemical resistant enclosure and self-healing window
- Large pushbuttons
- Clearly marked terminal labels

## Description



The +GF+ SIGNET 8750 pH/ORP Transmitter is designed for broad application and ease of setup and use. The unit auto-configures for either pH or ORP use when connected to +GF+ SIGNET pH or ORP sensors. Multiple mounting options allow for installation best suited to your particular application.

The automated “Easy-cal” menu features automatic buffer recognition for mistake proof pH or ORP sensor calibrations. Intuitive software and the four button keypad arrangement make it easy to access important information such as pH or ORP, mV input, temperature, calibration, relay set-up menus and more.

## Application

- Neutralization systems
- Heavy metals recovery
- Plating control
- Scrubber control
- Pool and spa control
- Environmental study
- Water treatment
- Water quality monitoring
- Waste treatment
- Disinfecting

## Technical Features

Mounting Version	Part No.	Wire Power	Sensor Input	4 to 20 mA Output	Open Collector/Relay
<b>Field</b> 	3-8750-1	2	1	1	1 O.C. Hi, Lo Pulse or Off
	3-8750-2	4	1	1	2 Relays Hi, Lo Pulse or Off
	3-8750-3	4	1	2 pH,Temp or ORP	2 O.C.'s Hi, Lo Pulse or Off
<b>Panel</b> 	3-8750-1P	2	1	1	1 O.C. Hi, Lo Pulse or Off
	3-8750-2P	4	1	1	2 Relays Hi, Lo Pulse or Off
	3-8750-3P	4	1	2 pH,Temp or ORP	2 O.C.'s Hi, Lo Pulse or Off

# Dimensions

## Panel Mount

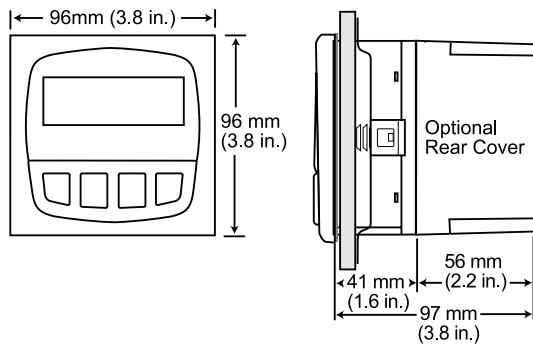

## Universal Mount

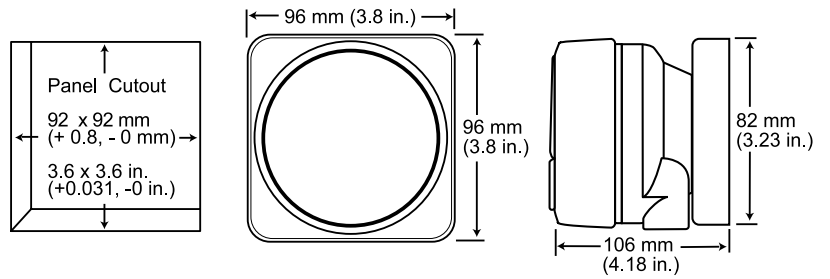

# Installation

The transmitter is available in a panel mount or a field version. Select the universal mount kit (3-8050) to mount the transmitter on a surface near the sensor.

## 1. Panel Mount

3-8750-XP

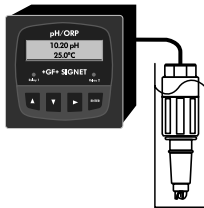

## 2. Universal Mount

3-8750-X Transmitter

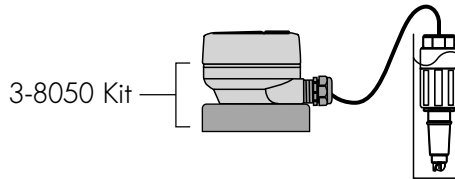

All panel mount transmitters (3-8750-XP) include a mounting bracket and gasket for a NEMA 4X watertight panel installation. Panel mount transmitters fit into a standard 1/4 DIN panel cutout.

The Universal Mount Kit (3-8050) can be ordered separately and includes a conduit base, locking ring, and universal adapter for mounting the transmitter on a pipe, wall, or other stationary surface.

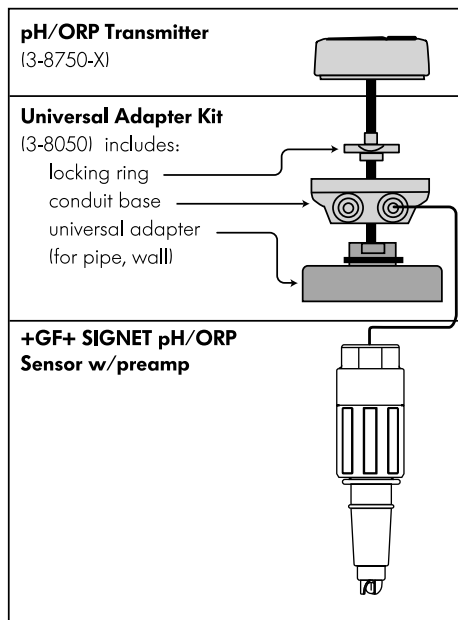
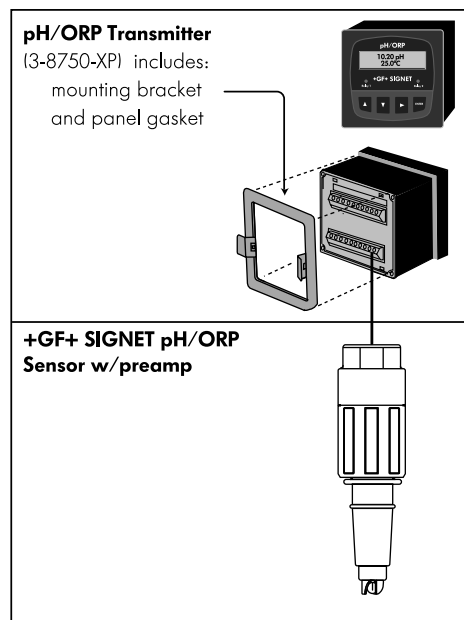

# Rear Terminal View

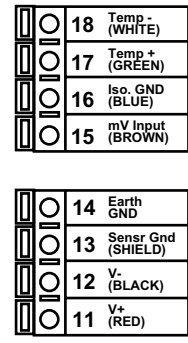
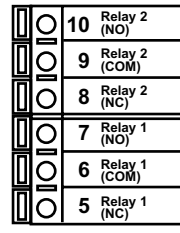
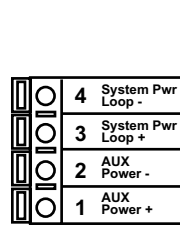
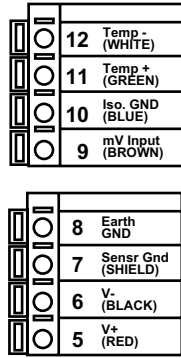
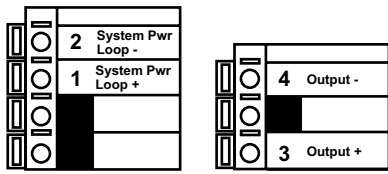

## 3. terminal 8750-1

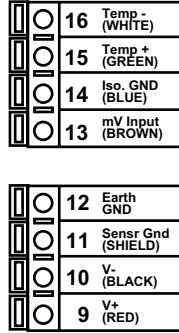
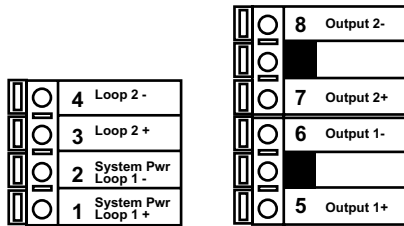

## 3. terminal 8750-2

## 3. terminal 8750-3

## Technical Data

### General

- Compatible electrodes: +GF+ SIGNET  
 3-27XX pH/ORP  
 Preamplifier/Electrodes  
 Accuracy:  $\pm 0.03$  pH,  $\pm 2$  mV ORP  
 Enclosure:
- Rating: NEMA 4X/IP65 front
  - Case: PBT
  - Panel case gasket: Neoprene
  - Window: Polyurethane coated polycarbonate
  - Keypad:  
Sealed 4-key silicone rubber
  - Weight: Approx. 325g (12 oz.)
- Display:
- Alphanumeric 2 x 16 LCD
  - Contrast: User selected, 5 levels

### Environmental

- Operating temperature:  
 -10 to 70°C (14 to 158°F)  
 Storage temperature:  
 -15 to 80°C (5 to 176°F)  
 Relative humidity:  
 0 to 95%, non-condensing

### Standards and Approvals

- CSA, CE, UL listed
- Manufactured under ISO 9001

### Electrical

- Power:
- 12 to 24 VDC  $\pm 10\%$  regulated
  - (-1) 21 mA max.: (-2) 220 mA max.:
  - (-3) 60mA max.
- Sensor input range:
- pH: 0.00 to 14.00 pH
  - temp. 3K Balco, -25 to 120°C (-13 to 248°F)
  - ORP: -1000 to +2000 mV, isolated (10K I.D. resistance T+, T-)
- Current output:
- 4 to 20 mA, isolated, fully adjustable and reversible
  - Max loop impedance:  
50 $\Omega$  max. @ 12 V  
325 $\Omega$  max. @ 18 V  
600 $\Omega$  max. @ 24 V
  - Update rate: 0.5 seconds
  - Accuracy:  $\pm 0.03$  mA @ 25°C, 24 V
- Relay output:
- Mechanical SPDT contacts: Hi, Lo, Pulse, Off
  - Maximum voltage rating: 5 A @ 30 VDC, or 5 A @ 250 VAC resistive load
  - Hysteresis: User-adjustable
  - Max 400 pulses/min.
- Open-collector output: Hi, Lo, Pulse, Off
- Open-collector, optically isolated, 50 mA max, sink, 30 VDC max. pull-up voltage.
  - Max 400 pulses/min.

## Ordering Information

Mfr. Part No.	Code	Description
3-8750-1	159 000 053	pH/ORP transmitter, Field mount
3-8750-1P	159 000 054	pH/ORP transmitter, Panel mount
3-8750-2	159 000 055	pH/ORP transmitter, Field mount with relays
3-8750-2P	159 000 056	pH/ORP transmitter, Panel mount with relays
3-8750-3	159 000 057	pH/ORP transmitter, Field mount with single input/dual output
3-8750-3P	159 000 058	pH/ORP transmitter, Panel mount with single input/dual output

## Accessories

Mfr. Part No	Code	Description
3-8050	159 000 184	Universal mounting kit
3-8050.395	159 000 186	Transmitter NEMA 4X cover
3-8050.396	159 000 617	RC Filter kit (for relay use)
3-0000.596	159 000 641	Heavy duty wall mount bracket
3-8050.392	159 000 640	Model 200 retrofit adapter
3-0700.390	198 864 403	pH buffer kit

## Engineering Specifications

- The transmitter shall be CSA, UL and CE listed.
- The transmitter shall be manufactured under ISO 9001 certified processes.
- The transmitter shall be field or panel mountable.
- The transmitter shall display pH, mV and temperature.
- The display units shall be fully scaleable.
- The device shall meet NEMA 4X and IP65 standards.
- The operating voltage shall be 12 to 24 VDC.
- The transmitter shall have a 4 to 20 mA output with an open collector output, 5 to 30 VDC or a 4 to 20 mA output with 2 relays, or dual 4 to 20 mA outputs with dual open collector capability.
- The transmitter shall have simulate capability.
- The transmitter shall hold an output value while calibrating.
- The transmitter shall be +GF+SIGNET, Model 8750 pH/ORP Transmitter.