

# +GF+ SIGNET 2450 Pressure Sensor

ENGLISH

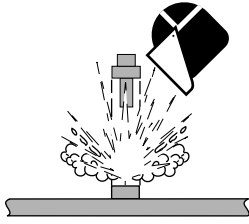

## Safety Instructions

1. Do not remove from pressurized lines.
2. Never install sensor without O-Rings.
3. Confirm chemical compatibility before use.
4. Do not exceed maximum temperature/pressure specifications.
5. Do not install/service without following mounting procedure.
6. Wear safety goggles and faceshield during installation/service.
7. Do not alter product construction.
8. Failure to follow safety instructions could result in severe personal injury.

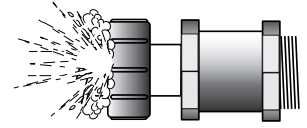

## 1. Installation

### 3/4" NPT (-1, -2):

1. Install in 3/4 in. NPT pipe fittings.
2. Tighten sensor 1.5 turns past finger tight.
3. A 3/4" pipe thread is provided to attach a cable conduit.

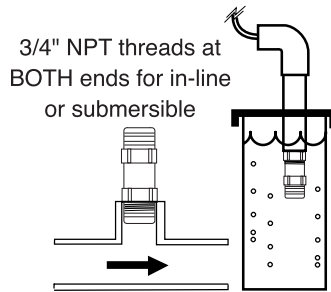

### 1/2" Male Union (-3, -4):

1. Slide union nut onto pipe or flexible tubing.
2. Install end connectors.
3. Hand-tighten union nut to secure.
4. A 3/4" pipe thread is provided to attach a cable conduit.

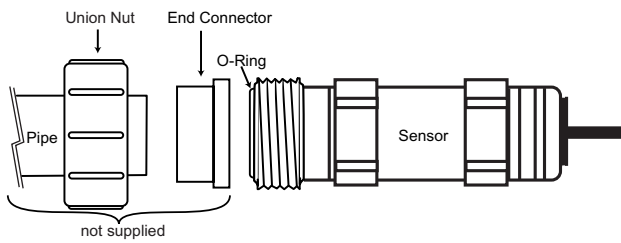

## 2. Wiring

Cable Length:	<b>2450-1x, -3x</b> 15 ft. (4.6m)	<b>2450-2x, -4x</b> 6 in. (15.2 cm)
---------------	--------------------------------------	--

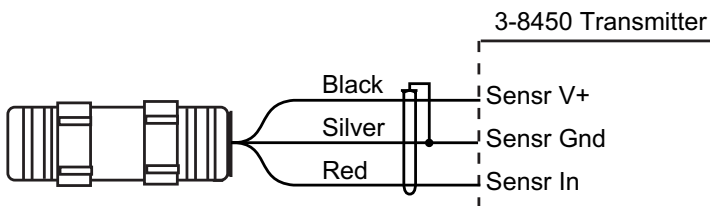

## 3. Parts and Accessories

Part No.	Description
5523-0222	Sensor cable (per ft.)

## 4. Specifications

### General

Operating Pressure:	<b>2450-XL</b> psig: 0-50 bar: 0-3.5	<b>2450-XH</b> psig: 0-250 bar: 0-17	<b>2450-XU</b> psig: 0-10 bar: 0-0.7
Proof Pressure:	psig: 75 bar: 5	psig: 300 bar: 20	psig: 20 bar: 1.5

### Application Limits

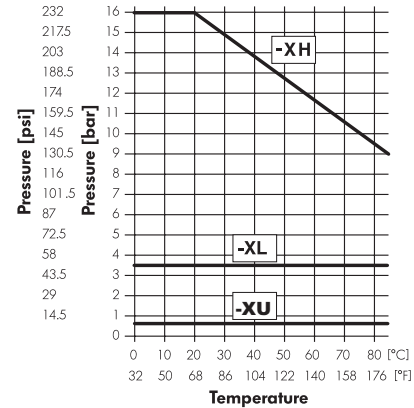

Process connection: 3/4 in. NPT or 1/2" Male Union  
 Accuracy: ±1% of full scale  
 Repeatability: ±0.5% of full scale

Wetted materials: PVDF, Ceramic, FPM (Viton®)  
 Cable type: PVC jacketed, 2-conductor twisted pair with shield (22 AWG)

Signal compatibility: +GF+ SIGNET 8450 Pressure Transmitter  
 Operating temperature: 0 to 85°C (32 to 185°F)  
 Storage temperature: -55°C to 100°C (-67°F to 212°F)

### Standards and Approvals

- Manufactured under ISO 9001
- CE

### Dimensions

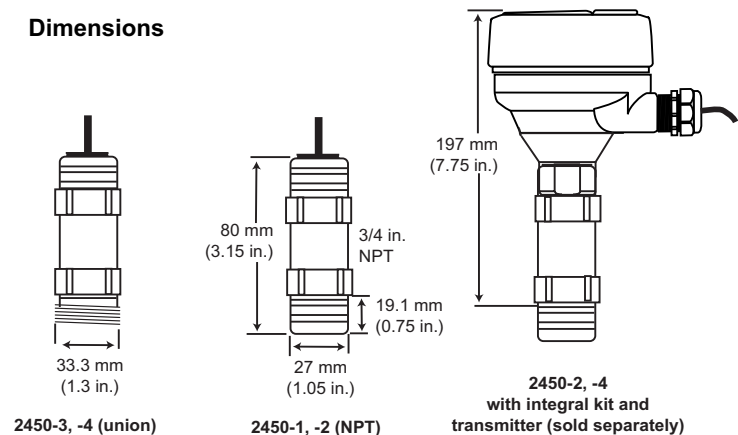

2450-3, -4 (union)

2450-1, -2 (NPT)

2450-2, -4 with integral kit and transmitter (sold separately)